

Child's bicycle seat OKBABY ORION

OKBABY S.r.l.

ENGLISH

Instructions for use and assembly

IMPORTANT/NOTE:

Read these instructions carefully and keep them in a safe place.
Follow and respect the safety warnings!
Become familiar with assembly
and use before using the child's seat.

Contents

1	Safety warnings	.65
2	Correct use	.67
3	Product overview	.67
4	Product description	.68
5	Signs and symbols	.68
6	Mounting and assembling the seat	.69
7	Use	.73
8	Optional accessories	.76
9	Cleaning and disposal	.77
10	List of problems	.77
11	Guarantee and assistance	.77
12	Technical information	.78
13	Conformity and manufacturer	.78

© 2007 Okbaby S.r.l.
Via del Lavoro 26
24060 Telgate BG Italy

The rights of translation, reproduction and total or partial adaptation and with any means are reserved for all countries.

1 Safety warnings



DANGER! Follow and respect the following safety warnings!
Otherwise, in the event of an accident or defect, the child's life may be in danger.

General warnings

The total weight of the rider, child and seat must not exceed the total load allowed for the bicycle.

Check that the bicycle is suitable for the addition of supplementary loads. We also recommend checking the information provided with the bicycle or asking for information and advice from its manufacturer.

Never carry two children at the same time on the seat or on the bicycle. An excessive load would prevent riding it correctly. It would also not be possible to guarantee the correct safety for the child.

Periodically check that the child's weight does not exceed the maximum weight allowed by the seat.

No modifications must be made to the child's seat! After an accident, have the seat checked by a specialized dealer or a specialist and have any damaged parts replaced.

The seat must in no case be used if it has not been checked or has any damaged parts!

The material of the seat (polypropylene) loses some of its mechanical properties with the ageing process, if exposed for a long period to the effects of the environment (sun, rain, ice etc.).

In the case of normal use and exposure to environmental effects, the seat should be replaced after three years.

Always remove the seat from the bicycle if it is carried on the roof of a car or in a bicycle carrier. Resistance of the air could ruin the seat or remove it from the bicycle. To carry a child under 7 on the seat, the person riding the bicycle must be at least 18 years old, according to the rules of the Highway Code in force in Italy. If the child's seat is to be used in other countries, please check on the laws in force each time.

For safety reasons, a protective helmet should be worn both by the person riding the bicycle and by the child.

Always ride carefully and respect the rules of the traffic.

OKBABY ORION child's bicycle seat

Place the child in the seat only if he/she can stay seated autonomously and without strain (from an age of about nine months and/or from a weight of about 9 kg.).

Safety of assembly and/or bicycle

The child's seat should be installed on touring bicycles with normal wheels. The use of the bicycle seat on racing bicycles with thin wheels may be a safety risk.

Cover the front wheel with suitable lateral protection (available at your specialized dealer) to prevent the child coming into contact with the wheel as it revolves.

To increase the stability of your bicycle, we recommend mounting a robust and stable kickstand.

Make sure that the child cannot operate safety or locking systems or other blocks on the bicycle, whilst in the seat.

Do not place bags or additional equipment on the seat.

If it were necessary to transport a bag or additional equipment, place it at the opposite end of the bicycle, for example, in the case of a seat fixed at the rear, position the additional load in the front and vice versa.

If the child's seat is not fixed correctly, this may endanger the child's life!

Before the first use:

After having installed the seat and put the child in it, before going out on to the road, become familiar with the bicycle and become aware that the balances and weights have changed.

Before each ride:

1) Check the support arm: it must be inserted in the correct position. Check that the support arm is fully inserted through the special stops on it and that the two safety springs, on the two sides of the fixing block, are in the correct housings. Pull the support arm upwards to check its resistance.

2) Check that the fixing block is tightly screwed.

It must not move and/or shift on the frame. Check it at regular intervals.

3) Make sure that the child's seat once installed does not compromise the action of the brakes and that the moving parts of the bicycle (pedals and front wheel) do not come into collision with the child's seat.

4) Failure to use the safety belt endangers the child's life!

Even when the fastening shackle is locked, always attach the safety belt to the child, even for only a short journey. The belts must be comfortable, but without sliding off the shoulders. If the seat is empty, tighten the safety belt in any case. Otherwise the belts could get tangled in any obstacles. Always attach the foot straps so that the child cannot get free.

5) The seat and the padding may heat up if exposed to the sun for any length of time. Ensure that they are not too hot before placing the child in the seat.

6) Make sure that the child and his/her clothing cannot come into contact with the moving parts of the bicycle, in particular the child's feet with the wheels, the fingers with the braking mechanisms and the support springs of the bicycle saddle. Periodically check these points as the child grows.

7) Make sure that the child cannot come into contact with any sharp objects on the bicycle such as frayed or worn brake cables.

Whilst riding:

Never park the bicycle leaving the child in the seat, even if the position of the bicycle seems stable. If the child is in the seat, the bicycle must always be held by the person riding it.

Consider that the child perceives the climatic conditions (wind, cold, etc.) differently, as he/she is not moving. Therefore the child must be protected with adequate clothing.

2 Correct use

The ORION child's seat is designed and allowed to transport children weighing between 9 and 15 kg and/or between approximately 9 months and 2 years of age.

The child to be carried must be able to sit up straight alone.

The child's seat can be mounted on bicycles or on bicycles with electrical motor-assisted pedalling; mounting on two-wheeled vehicles other than these (such as scooters, motorcycles, motorbikes etc.) does not comply with provisions and therefore is prohibited.

The seat is mounted in front of the person riding the bicycle, on the steering pillar or on the frame of the bicycle as shown in the figures of these assembly instructions. Any other use is unacceptable.

3 Product overview

The position numbers refer to the following figure and you will find these numbers in brackets in Chapters 6 and 7.

- 1 Seat
- 2 Padding (fixed with Velcro system)
- 3 Safety belts
- 4 Footrests with respective belt
- 5 Fastening shackle
- 6 Support arm
- 7 Fixing block
- 8 Fixing counter-block
- 9 4 long screws with respective nuts and Allen wrench
- 10 2 short screws with respective nut
- 11 Reductions for different diameters of bicycle frames
- 12 Seat fixing plate
- 13 2 closing caps and relative screw with nut (when the fastening shackle is to be removed)
- 14 Hexagon ring wrench

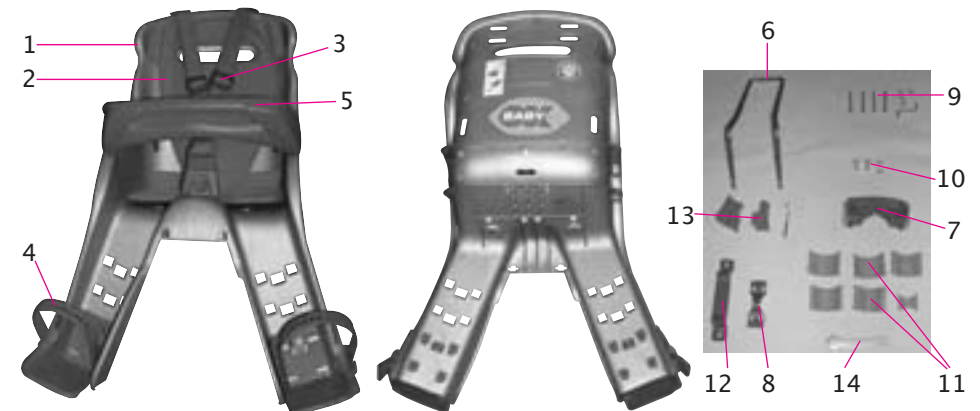



Supply of OKBABY ORION child's bicycle seat

4 Product description

The seat is suitable for cycles with 26"/28" wheels and frames with a round section diameter of 32–52 mm. It cannot be mounted on frames of a different diameter. Contact the manufacturer if you are not sure whether the seat is suitable for your bicycle.

5 Signs and symbols

Chapter 6 describes the assembly and chapter 7 the fundamental use of the bicycle seat. Read these chapters carefully to understand and put the possibilities and functions into practice. The following terms and symbols are used:

Symbol	Term	Meaning
	DANGER	Warning of possible serious or fatal injury to persons
	WARNING	Warning of possible slight injury to persons or damage to things
	ATTENTION	Warning of any defects and/or destruction of product
IMPORTANT/NOTE		An important or useful note is provided

6 Mounting and assembling the seat

 **WARNING!** Follow the safety warnings (see Chapter 1) to avoid injury or damage due to assembly mounting errors! Do not use the seat if it is damaged!

IMPORTANT/NOTE: The numbers in brackets refer to Chapter 3 "Product overview".

IMPORTANT/NOTE: Whilst fixing the seat to the bicycle, take care not to damage or trap any brake wires or wires of the bicycle's electrical system.

Illustration 1: Holding the seat upside-down, insert the support arm (6).

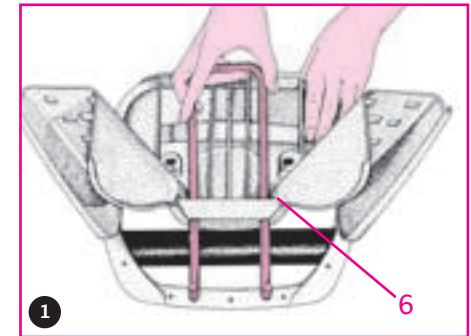

Illustration 2: After having lifted up the padding, in the seating area, insert the shortest two screws (10) in the holes.

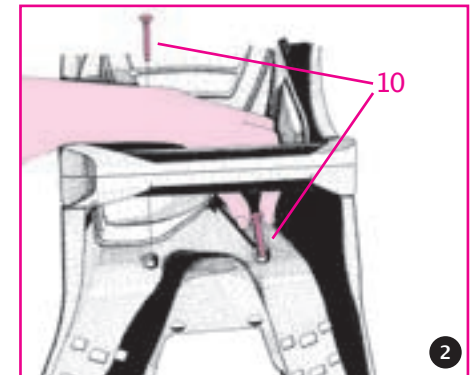

Illustration 3: Then place the fixing plate (12) in correspondence with the screws (10) protruding from the bottom of the seat. At this point, after having slid on to both screws the toothed washer supplied, fix the bracket with the two hexagonal nuts.

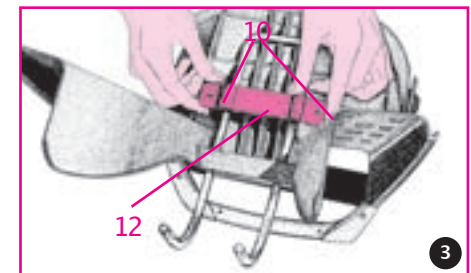
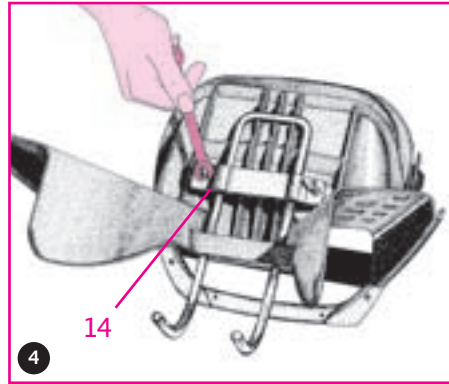
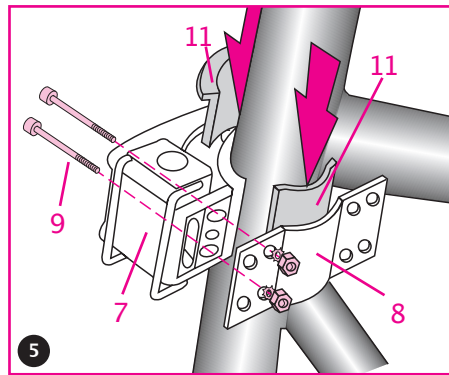

Illustration 4:

After having positioned the support arm, with the screws loose, in one of the three possible positions (usually the intermediate one is the most commonly used) tighten the nuts with the wrench (14) supplied until completely fixed.

**Illustration 5:**

Choose the plastic reducers (11) suitable to the diameter of the crossbar of your bicycle. Insert the reducers (11) into the fixing block (7) and the fixing counter-block (8). Assemble the fixing block (7) with the fixing counter-block (8) using the four screws (9) with their respective washers and nuts. Leave the screws (9) slightly loose in order to be able to proceed with any adjustments in height and in rotation.



The support must only be placed in the direction of travel as shown in illustration 6.

Illustration 6:

Take the seat and insert the ends of the support arm (6) in the two holes 16 on the fixing block. Check that the support arm is in place by means of the special stops on it and that the two safety springs 15, on the two sides of the fixing block, are inserted in the appropriate housings on the support arm. At this stage, check that:

- the handlebar interferes as little as possible with the seat and allows you to steer normally;

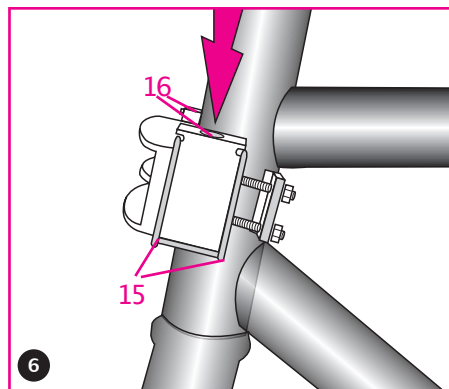

- the child's seat does not cause any particular difficulties whilst pedalling. If any of these situations arises, refer to illustrations 4 and 5 on the previous page.

Illustration 4:

Loosen the fixing nuts under the seat and move it frontward or backwards as required, tightening the nuts again.

Illustration 5:

Compatibly with the height of the crossbar of your bicycle, you can also move the fixing block upwards or downwards, loosening the four screws (9), and then tighten them again after having found the most satisfactory position. Tighten the screws (9) gradually and evenly until the fixing block no longer rotates around the frame. Avoid excessive tightening of the screws.

Illustration 7:

To extract the child's seat from the fixing block, push the two safety springs 15 inwards whilst sliding the support arm out of the holes.

⚠ DANGER! Always check that the bicycle handlebar does not remain caught in the child's seat whilst steering.

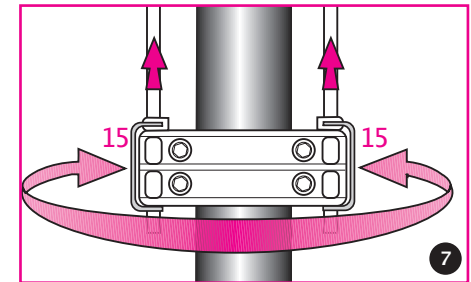
**Illustration 8:**

Insert the footrests (4) with the respective belt in the relative housings.

⚠ ATTENTION! Take care to insert the correct footrest in its housing, bearing in mind that there is one footrest for the right foot and one for the left foot.

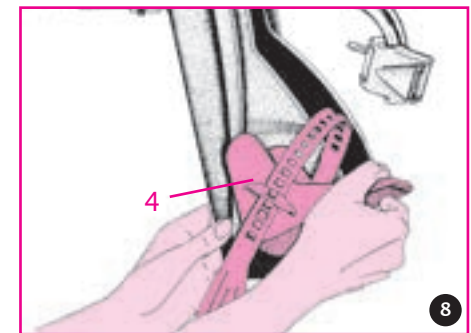
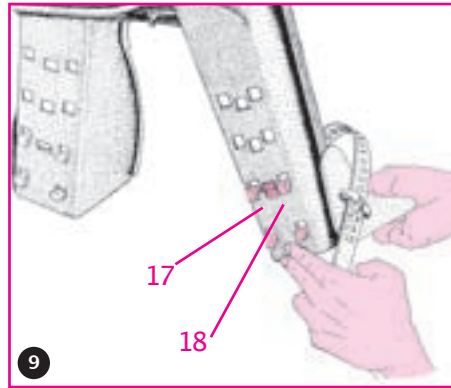

Illustration 9:

Pass the four hooks 17 into their seatings and push downwards until the catch snaps 18. If the footrests are not in the desired position and you want to move them, follow these instructions:

- push the catch 18 with a finger from the outside and with the other hand raised, remove the footrest from its seating;
- select the position desired and repeat the first step of this paragraph.



IMPORTANT/NOTE: select a correct position depending on the length of your child's legs so that while using the seat he/she does not feel pain or get cramp.

⚠ DANGER! Replace the handlebar of the bicycle with a suitable model if the steering angle is less than 45° per side.

7 Use

⚠ ATTENTION! The child's seats reduce the manoeuvrability of the bicycle.

IMPORTANT/NOTE: Use the seat only and exclusively between the handlebar and the person riding the bicycle as per the drawing alongside.

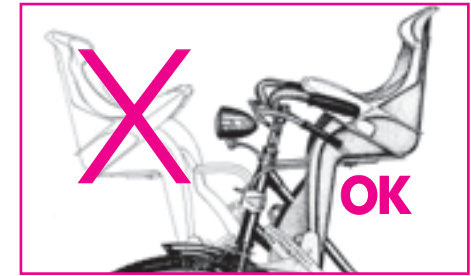
**Illustration 1:**

Unlike other products, the Orion child's seat, as well as having safety belts, has a fastening shackle that prevents the child getting up and moving dangerously whilst being carried. To open the fastening shackle, push button 19, and extract the shackle from its housing by rotating it all the way round until it stops.

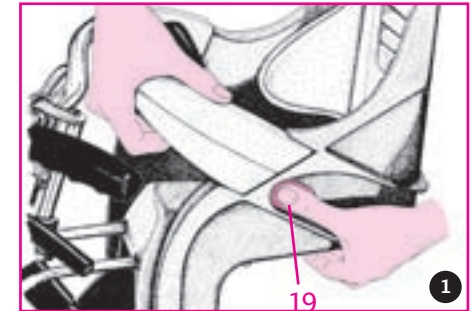
**Illustration 2:**

After having seated the child, close the bar until button 19 is completely inserted in its housing. Then check that the bar is blocked.

⚠ WARNING! When you close the fastening shackle, take care not to catch or pinch the child's fingers.

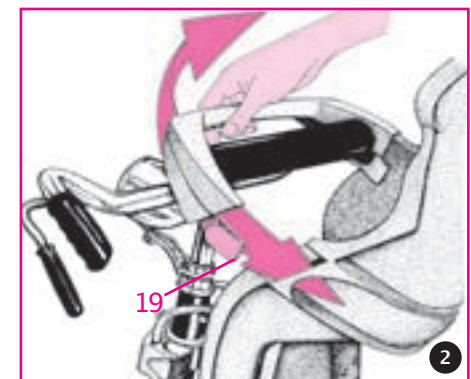
**Illustration 3:**

When the child is seated in the seat, secure his/her feet, passing the belt under the bridge 20, block the belt on the pin 21 in the position desired. To release the child's feet, pull the belt outwards to release it from the pin 21.

IMPORTANT/NOTE: Do not tighten the belts on the child's foot excessively, you could cause cramp or pain.

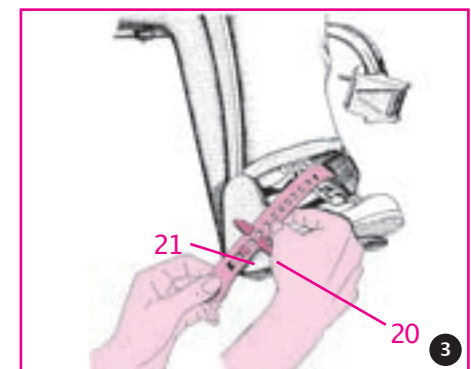

⚠ WARNING! Always check that the foot does not come out of its respective footrest, pulling the child's leg up.

Illustration 4:

The child's fastening shackle, which is a standard fitting on the seat you have purchased, is very suitable for children only a few months old (from 7 Kg to 10 Kg). When the child weighs more than 10 kg, the fastening shackle could be too tight for the child and as a result it may be necessary to remove it, thus being able to use the seat for a child weighing up to a maximum of 15 Kg.

To remove the fastening shackle, exercise pressure with a normal screwdriver, removing the cap blocking the pin.

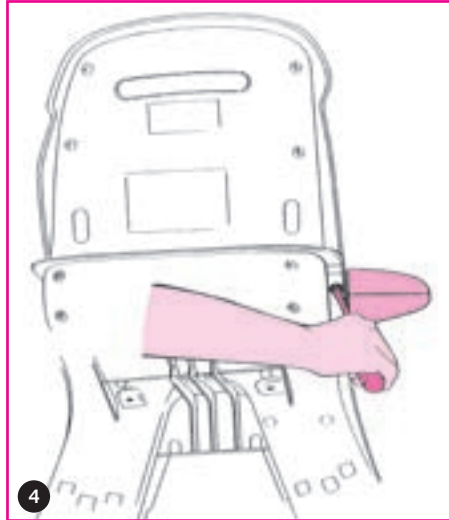
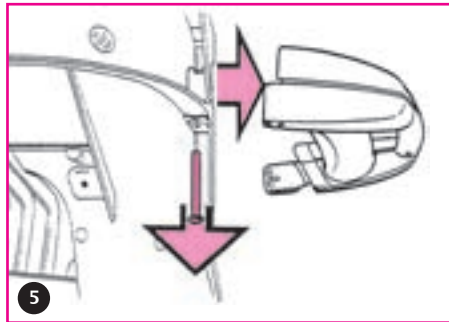

Illustration 5:

At this point the pin can be extracted from the housing, releasing the fastening shackle.



⚠ DANGER! The safety belts must always be used even when the fastening shackle is removed.

Illustration 6:

Snap into place the two caps (13) using slight pressure, to close the openings that have formed due to the absence of the fastening shackle.

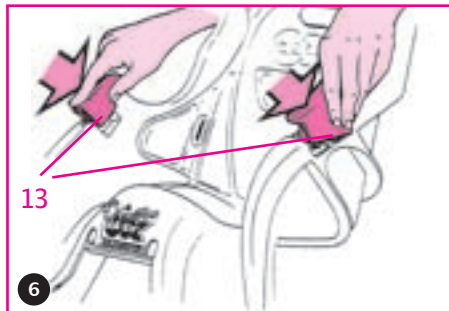

Illustration 7:

If you want to replace the fastening shackle, remove the closing caps (13) and put the fastening shackle back into place using the relative screw and nut, tightening it with the wrench supplied (14).

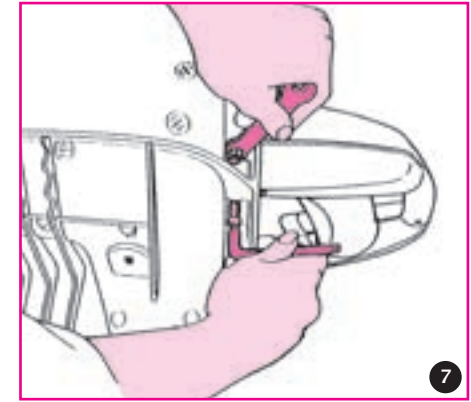

Illustration 8:

Fasten the child's belt. Adjust the length of the belt according to the child's height.

Adjust the length of the belt: move the length of the belts by sliding the buckles of the belt. The belts must be fastened firmly without the child being too tight.

Fasten the belt system:

Close the belt. Check that the fastening of the belt snaps correctly into position, pulling the belt after the snap.

Undoing the belts:

Push the two buttons (front and rear) on the closure at the same time. The fastening is unblocked.

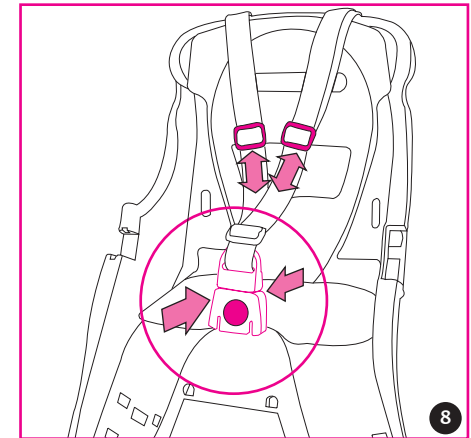

IMPORTANT/NOTE: To ensure maximum safety, it has been made slightly difficult to unblock the belt.

⚠ DANGER! The fastening of the belt is an important element for safety and must be inserted in all cases. The correct fastening must be checked before each ride! The life of a child who is not secured is in danger!

8 Optional accessories

Fixing Block no. 37640000

To be fixed to the bicycle crossbar.
Supplied with support arm.
Adjustable inclination.
Diameter of frame 30–65 mm
(round section)
Diameter of frame 35–70 mm
(elliptical section)



Fixing block no. 37660200

To be fixed to the tube under the steering system.
The support arm is not supplied with the fixing block.
Diameter of frame 32–52 mm.



Wind Stop windscreen no. 37210000

Made from flexible and shatterproof Lexan polycarbonate.
Complete with fixing block.

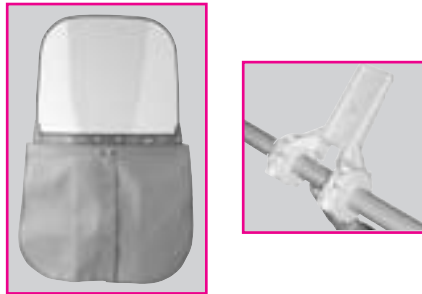

Supplementary Wind Stop fixing block no. 37219999

9 Cleaning and disposal

Clean the belts, the seat and the padding with warm water and a neutral detergent for delicate items. Do not use solvents or corrosive and abrasive detergents in order not to scratch the seat. Leave the padding to dry in the air. Do not iron! The seat and all its accessories must be disposed of and recycled at the various ecological stations or platforms. Identify the ecological platform or station nearest to you, the specialized personnel will recycle all the components without polluting. Do not dispose of the seat in the rubbish bins!

10 List of problems

Problem	Possible cause/s	Remedy
The blocking screws cannot be tightened and/or have been tightened excessively during assembly		<ul style="list-style-type: none"> • Replace the screws and nuts. • Only use screws that correspond to the original screws and/or get information from the manufacturer/dealer. • Use self-blocking nuts.
The fixing block cannot be fixed completely to the bicycle frame	The thickness of the reducers or the shape of the bicycle frame are not suitable.	<ul style="list-style-type: none"> • Use the suitable thickness reducer • Fix the seat to a frame of a suitable dimension.



DANGER! Do not make any modifications to the product! Parts that are important for safety must be repaired by specialized personnel only.

11 Guarantee and assistance

In all the countries of the European Union, Okbaby assumes all and only the manufacturer's legal obligations of guarantee according to the relevant Community rules, and in particular Directive no. 99/44/EC and the corresponding national laws of implementation (in Italy: articles 1519-bis and following of the Civil Code) which foresee 2 years of guarantee.

For the above guarantee to be applied, please pay special attention to all the indications shown above and in particular those relative to the characteristics of the product and its performances; the assembly and/or installation instructions and any rules on this being performed by specialized personnel; the conditions of normal use of the product; any special warnings regarding safety and precautions in using the product.

In particular, the guarantee is not applicable in the event of damage caused by neglect, use or installation that does not comply with the instructions provided, damage due to accidental causes or negligence by the purchaser. The parts subject to wear following use, which do not show manufacturing defects, are also excluded from the guarantee.

With the exception of what is expressly laid down by the law, claims for the guarantee are not to be made directly with the manufacturer but with the retailer from whom you purchased the product. Please keep the receipt or purchase invoice in a safe place.

Repairs must be carried out only by authorized and specialized personnel.

Address for assistance :

Telephone: +39 (035) 830004

Fax: +39 (035) 832961

E-mail for technical information : aq.baldelli@okbaby.it

12 Technical data

Product	OKBABY ORION Child's bicycle seat
Dimensions	54x45x33 cm (HxLxD)
Weight	2200 g

13 Conformity and manufacturer

In conformity with the following European Directives, the following mark has been applied:

EN 14344

The declaration of conformity has been registered with the manufacturer.

Manufacturer:

OKBABY SRL

Via Del Lavoro 26

24060 Telgate BG Italy

www.okbaby.it